

REVISION HISTORY

REV	DESCRIPTION	DATE	APPROVED	Revised By
A	Initial Design Release	3/8/2007		

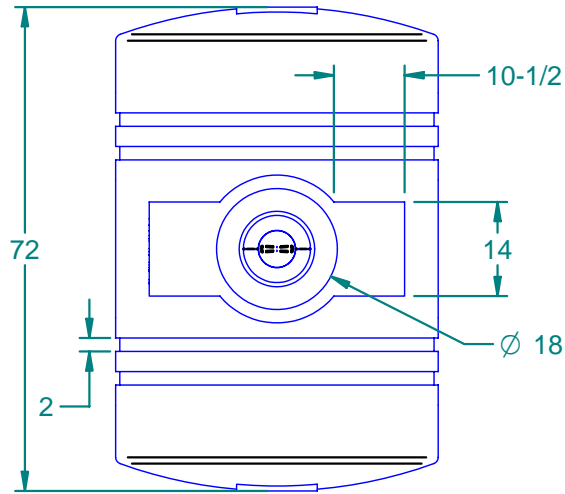

Gallons Calibration
25 Gal Intervals
Typical Both Ends
(not shown)

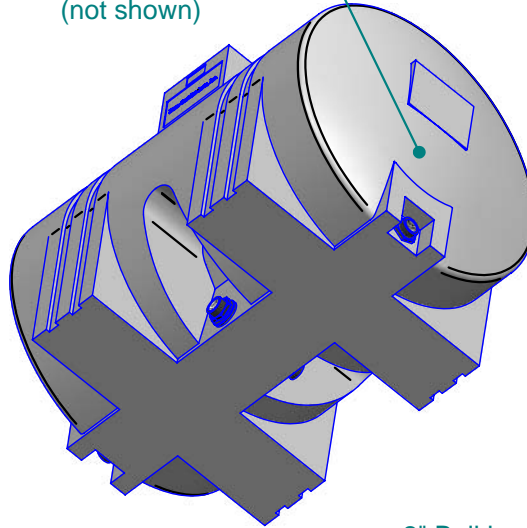

8" Manway Lid

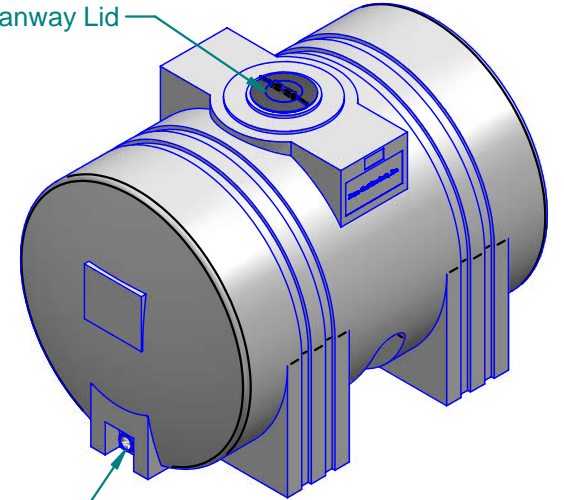

2" Bulkhead Fitting

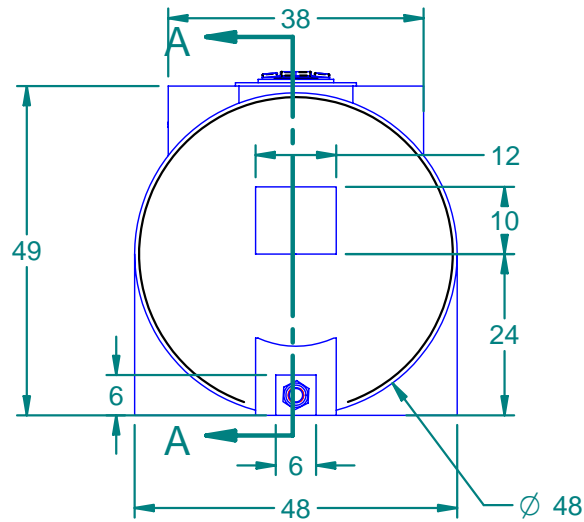

Dura-Cast Label

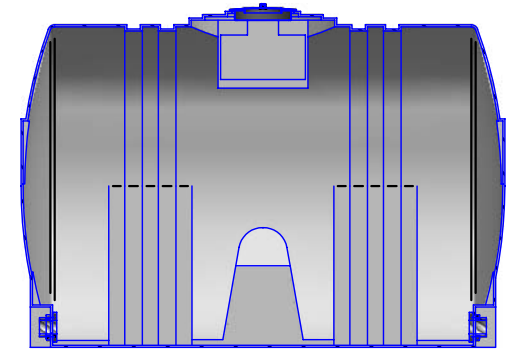
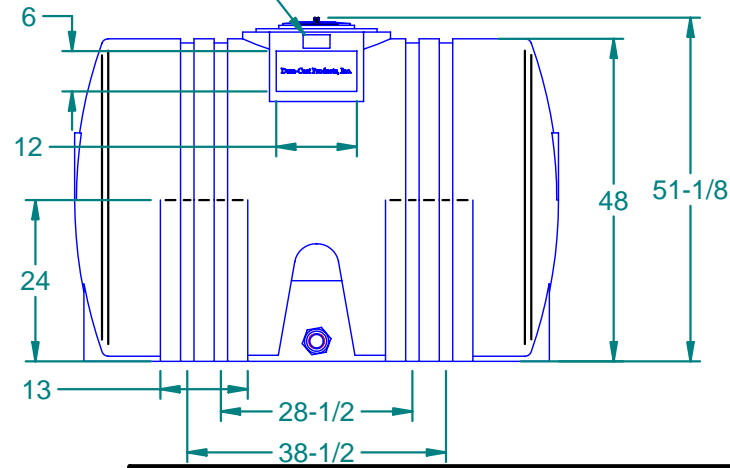

SECTION A-A

Weight: 130,218 lbm		NAME	DATE		
Wall Thickness: Name?Wall Thickness	DRAWN By:	mnegron	3/8/2007		
Customer Part No: Name?Customer Part No	Customer APPR			Customer:	
Print Date: 3/8/2007	MFG APPR			Part Title:	
Comments:	Tolerance: UNLESS OTHERWISE SPECIFIED DIMENSIONS ARE IN INCHES ±1% Std Radii 3/16"	File Name:		Size: A	Material:
		Part No:		Do Not Scale	Sheet: 1 OF 1