

WATER

SNYDER INDUSTRIES INC.

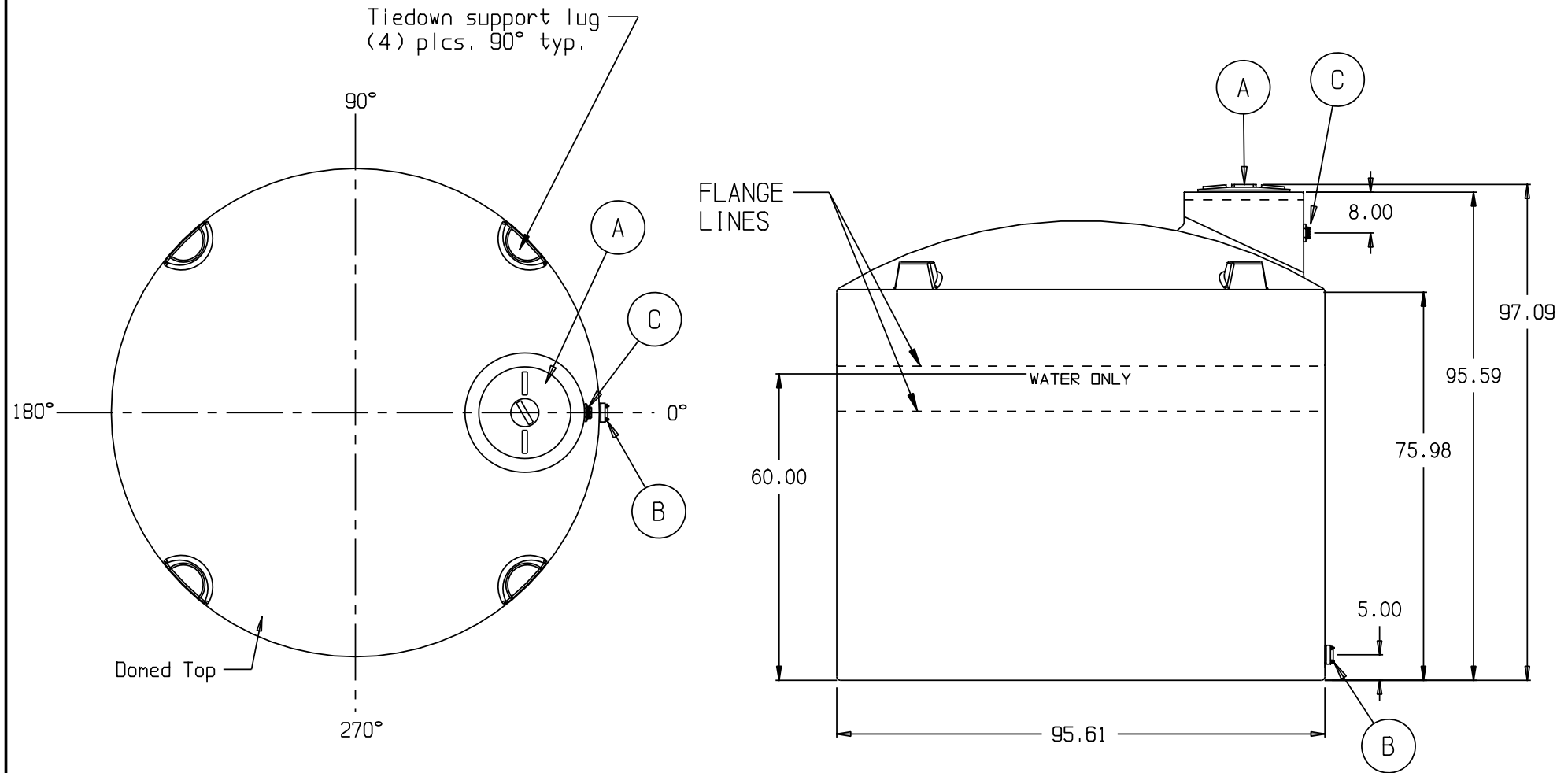

- A. 18" PE THREADED-VENTED MANWAY W/15" ACCESS [P/N 34700087]
- B. 2" PP DBL FLANGED BOLTED FTG W/EPDM GASKETS & SS BOLTS [P/N 34100103]
- C. 1-1/2" PP T x T BH BANJO FTG W/EPDM GASKET [P/N 34100144]

* BASE FITTINGS TO BE LEFT INSTALLED AT TIME OF SHIPMENT PER SII PROCEDURE
* Consult Snyder's Guidelines for Use and Installation prior to delivery.
Available on-line at www.snydernet.com

(all dimensions in inches)

PART # TANK: 5090200W94203 & 99803 (C)
HDLPE/BLK & GDD/WATER

2,600 GALLON BLACK & DARK OLIVE GREEN WATER TANK

REF#: 0000

11/09/09