

WATER

SNYDER INDUSTRIES INC.

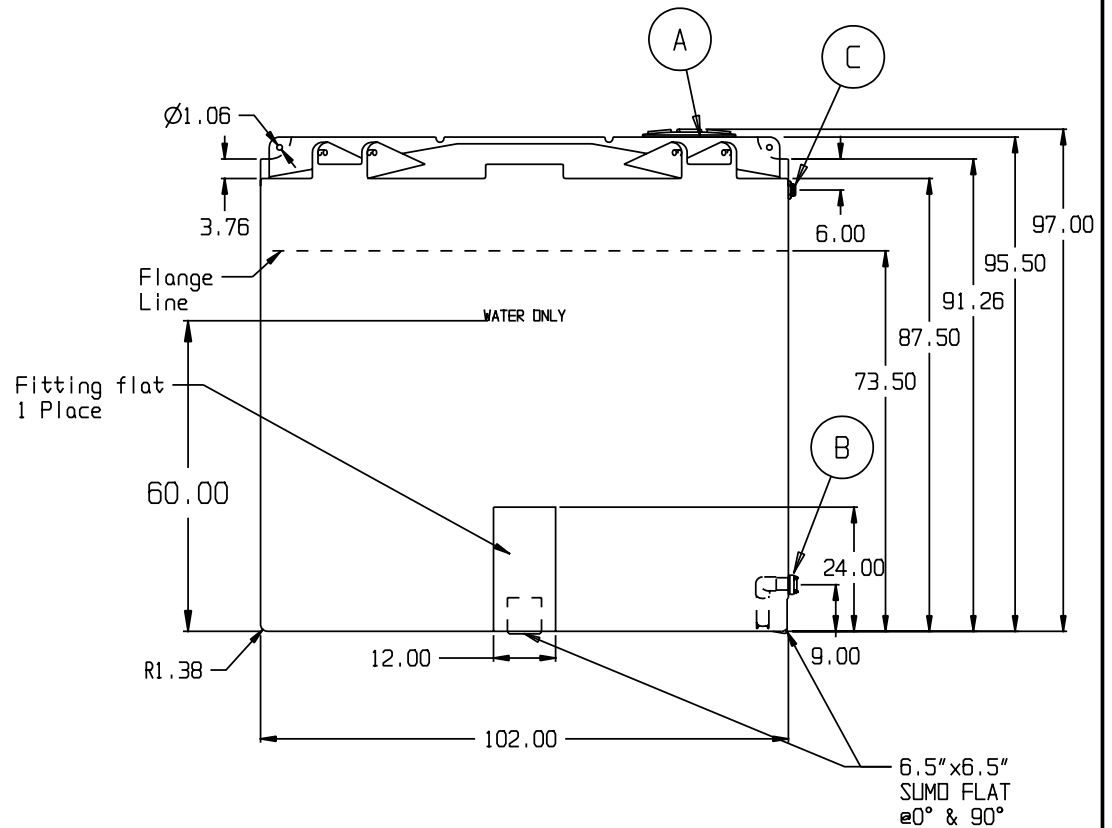
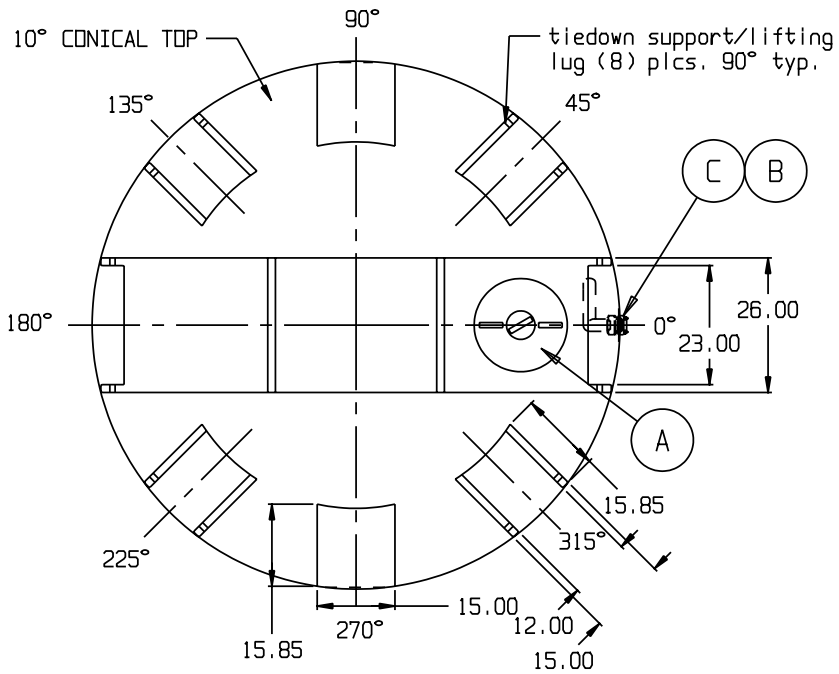

- A. 18" PE THREADED-VENTED MANWAY W/15" ACCESS [P/N 34700087]
- B. 2" PP DBL FLANGED BOLTED LONG SIPHON TUBE ASSY W/EPDM GASKETS & SS BOLTS [P/N 34700841]
- C. 1-1/2" PP TxT BH BANJD FTG W/EPDM GASKET [P/N 34100144]

* BASE FITTINGS TO BE LEFT INSTALLED AT TIME OF SHIPMENT PER SII PROCEDURE
 * Consult Snyder's Guidelines for Use and Installation prior to delivery.
 Available on-line at www.snydernet.com

(all dimensions in inches)
 PART # TANK: 7410000W94201 & 99801 (L)
 HDLPE/BLK & GDD/WATER

3,000 GALLON BLACK & DARK OLIVE GREEN WATER TANK

REF#: 0000

04/04/07