

REF. _____

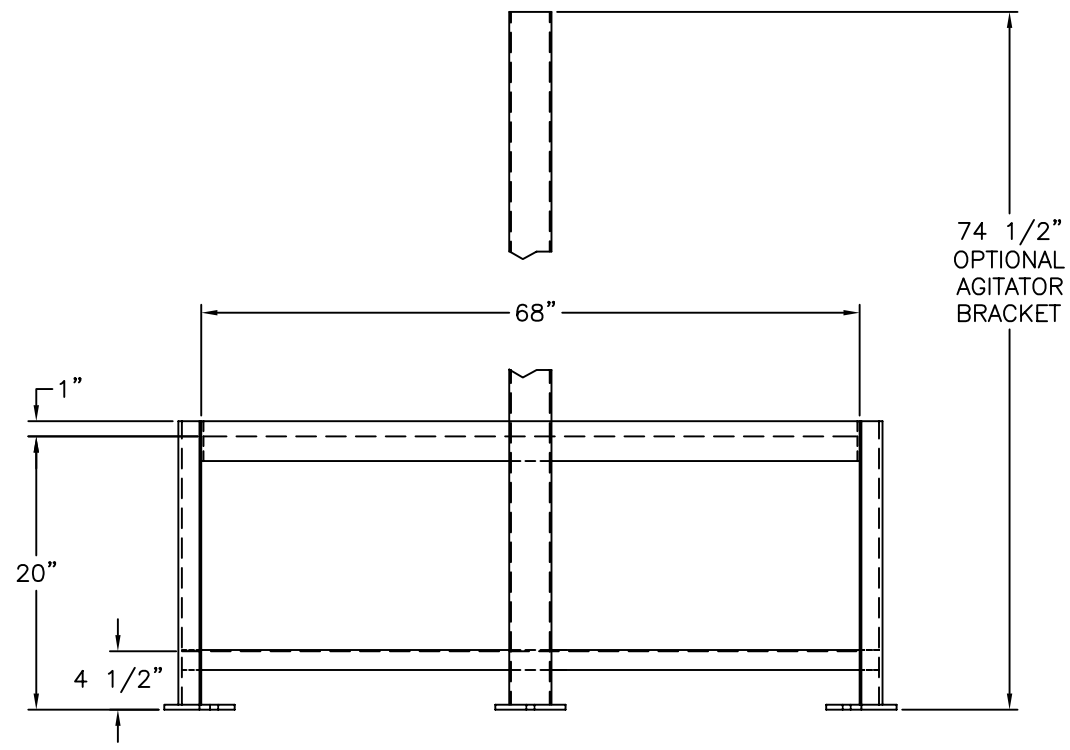

NOTE:
ALL DIMENSIONS ARE APPROXIMATE
NOT INTENDED FOR FABRICATION

Rev. 0	Date	File Name	
CHEM-TAINER Industries Inc. 361 Neptune Ave. N. Babylon, NY 11704 (631) 661-8300 Fax: (631) 661-8209		Date 02/22/05	Scale
		Drawn By: K.Y.	Cust. Rep.
TITLE 675 GALLON FLAT BOTTOM METAL STAND			
Part # TC-6646AK/AM		Dwg. #	